



SPLIT SYSTEM AIR CONDITIONER USER MANUAL

**MODEL NUMBERS:
ACSS25, ACSS35, ACSS50, ACSS72**

Thank you for choosing Emerald Energy.

This leaflet contains important information on the correct installation and operation of your split system air conditioner.

Read these instructions carefully before installation. Keep this manual in a handy for future reference.

IMPORTANT NOTICE

Please read this manual carefully before you attempt to install this product. Failure to do so may result in the product not working according to its design.



CONTENTS

SAFETY INSTRUCTIONS	3	Eco mode	18
PREPARATION BEFORE USE	4	lfeel function	18
SAFETY PRECAUTIONS	5	Clean function	18
INSTALLATION INSTRUCTIONS	10	INSTALLATION INSTRUCTIONS	19
DISPLAY INTRODUCTION	12	Select the installation locations	19
REMOTE CONTROLLER	13	Indoor unit installation	20
Operation modes	15	Connecting of the cable	22
Airflow direction control	16	Wiring diagram	23
Clock button	16	Outdoor unit installation	23
Timer mode	16	Air purging	24
Sleep mode	17	MAINTENANCE	25
8°C Heat mode	17	PROTECTION	26
Turbo mode	17	TROUBLESHOOTING	27
Mute mode	18		

SAFETY INSTRUCTIONS

- To guarantee the unit work normally, please read the manual carefully before installation, and try to install strictly according to this manual.
- Do not let air enter the refrigeration system or discharge refrigerant when moving the air conditioner.
- Properly ground the air conditioner into the earth.
- Check the connecting cables and pipes carefully, make sure they are correct and firm before connecting the power of the air conditioner.
- There must be an air-break switch.
- After installing, the consumer must operate the air conditioner correctly according to this manual, keep a suitable storage for maintenance and moving of the air conditioner in the future.
- Fuse of indoor unit: T 3.15A 250VAC or T 5A 250VAC. Please refer to the screen printing on the circuit board for the actual parameters, which must be consistent with the parameters on the screen printing.
- For 2.5,3.5KW models, fuse of outdoor unit: T 15A 250VAC or T 20A 250VAC. Please refer to the screen printing on the circuit board for the actual parameters, which must be consistent with the parameters on the screen printing.
- For 5.0KW models, fuse of outdoor unit: T 20A 250VAC.
- For 7.1 KW models, fuse of outdoor unit: T 30A 250VAC.
- The installation instructions for appliances that are intended to be permanently connected to fixed wiring, and have a leakage current that may exceed 10 mA, shall state that the installation of a residual current device (RCD) having a rated residual operating current not exceeding 30 mA is advisable.
- Warning: Risk of electric shock can cause injury or death: Disconnect all remote electric power supplies before servicing.
- This appliance is not intended for use by persons (including children) with reduced physical, sensory or mental capabilities, or lack of experience and knowledge, unless they have been given supervision or instruction concerning use of the appliance by a person responsible for their safety. Children should be supervised to ensure that they do not play with the appliance. Cleaning and user maintenance shall not be made by children without supervision.
- This appliance can be used by children aged from 8 years and above and persons with reduced physical, sensory or mental capabilities or lack of experience and knowledge if they have been given supervision or instruction concerning use of the appliance in a safe way and understand the hazards involved. Children shall not play with the appliance. Cleaning and user maintenance shall not be made by children without supervision.
- The batteries in remote controller must be recycled or disposed of properly.
Disposal of Scrap Batteries --- Please discard the batteries as sorted municipal waste at the accessible collection point.
- If the appliance is fixed wiring, the appliance must be fitted with means for disconnection from the supply mains having a contact separation in all poles that provide full disconnection under over voltage category III conditions, and these means must be incorporated in the fixed wiring in accordance with the wiring rules.
- If the supply cord is damaged, it must be replaced by the manufacturer, its service agent or similarly qualified persons in order to avoid a hazard.
- The appliance shall be installed in accordance with national wiring regulations.
- Servicing shall only be performed as recommended by the equipment manufacturer. Maintenance and repair requiring the assistance of other skilled personnel shall be carried out under the supervision of the person competent in the use of flammable refrigerants.
- The appliance shall not be installed in the laundry.
- Regarding to installation, please refer to section "Installation instructions".
- Regarding to maintenance, please refer to section "Maintenance".
- The AC is not allowed to install in the mining area and sand storm area.

PREPARATION BEFORE USE

NOTE

- When charging refrigerant into the system, make sure to charge in liquid state. Otherwise the chemical composition of refrigerant (R32) inside the system may change and thus affect the performance of the air conditioner.
- The GWP of R32 refrigerant is 675. The pressure of the system is very high, so be sure to be careful when you install and repair the appliance.
- If the supply cord is damaged, it must be replaced by the manufacturer, its service agent or similarly qualified persons.
- Installation of this product must be done by experienced service technicians professional installers in accordance with this manual.
- The temperature of refrigerant circuit will be high, please keep the interconnection cable away from the copper tube.

PRESET

Before using the air conditioner, be sure to check and preset the following.

REMOTE CONTROL PRESETTING

After replacing the batteries in the remote control or turning it on, the remote control will automatically set to the smart mode.

BACK-LIGHT FUNCTION OF REMOTE CONTROL (OPTIONAL)

Hold down any button on the remote to activate the back light. It automatically shuts off 10 seconds later.

AUTO RESTART PRESETTING

The air conditioner has an Auto-Restart function.

SAFEGUARDING THE ENVIRONMENT

This appliance is made of recyclable or re-usable material. Scrapping must be carried out in compliance with local waste disposal regulations. Before scrapping it, make sure to cut off the mains cord so that the appliance cannot be re-used.

For more detailed information on handling and recycling this product, contact your local authorities who deal with the collection of rubbish.

DISPOSING OF APPLIANCE

This appliance is marked according to the European Directive 2012/19/EC, Waste Electrical and Electronic Equipment (WEEE).

This marking indicates that this product should not be disposed with other household wastes throughout the EU. To prevent possible harm to the environment or human health from uncontrolled waste disposal, recycle it responsibly to promote the sustainable reuse of material resources. To return your used device, please use the return and collection systems or contact the retailer where the product was purchased. They can take this product for environmental safe recycling.



SAFETY PRECAUTIONS

SYMBOLS

 Do not do
  Pay attention
  Grounding is essential

 Warning: Incorrect handling could cause a serious hazard, such as death, serious injury, etc.

 Use correct power supply in accordance with the rating plate requirement. Otherwise serious faults or hazards such as fire may occur.



 Keep the power supply circuit breaker or plug free from dirt. Firmly connect the power supply cord to it to avoid electric shock or fire due to insufficient contact.

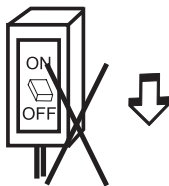

 Do not use the power supply circuit breaker or pull off the plug to turn off during operation. This may spark a fire.

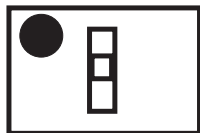

 It is the user's responsibility to ground the appliance according to local codes or ordinances by a licensed technician.

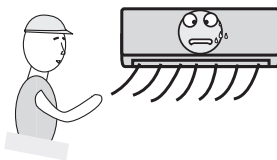

 Prolonged exposure to cool air can be detrimental to your health. It's recommended to ensure even distribution of airflow throughout the entire room.

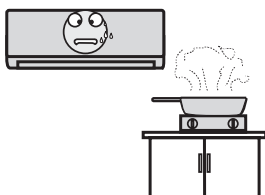

 Prevent the airflow from reaching the gas burners and stove.

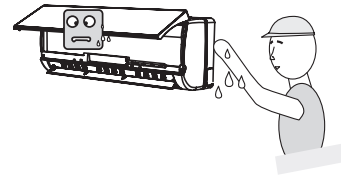

 Do not touch the operation buttons when your hands are wet.



 If a malfunction occurs, first deactivate the appliance using the remote control, and then proceed to disconnect the power supply.

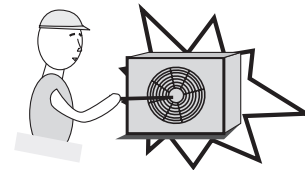

 Never insert sticks or similar objects into the unit. The fan rotates at high speed and doing so could result in injury.

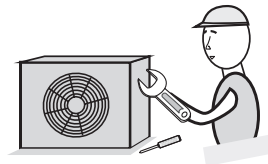

 Do not repair the appliance by yourself. If it is done incorrectly it may cause an electric shock or similar.

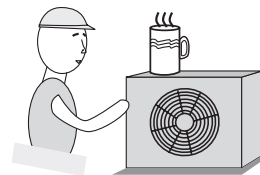

 Do not put any objects on the outdoor unit.



 Handle the power supply cord with care and avoid knots, pulling, or pressing it to prevent breakage. A broken power supply cord can lead to electric shock or fire hazards.

SAFETY PRECAUTIONS

PRECAUTIONS FOR USING R32 REFRIGERANT

CAUTION

1. Transport of equipment containing flammable refrigerants

Compliance with the transport regulations

2. Marking of equipment using signs

Compliance with local regulations

3. Disposal of equipment using flammable refrigerants

Compliance with national regulations

4. Storage of equipment/appliances

The storage of equipment should be in accordance with the manufacturer's instructions.

5. Storage of packed (unsold) equipment

- Storage package protection should be constructed such that mechanical damage to the equipment inside the package will not cause a leak of the refrigerant charge.
- The maximum number of pieces of equipment permitted to be stored together will be determined by local regulations.

6. Information on servicing

6-1 Checks to the area

Prior to beginning work on systems containing flammable refrigerants, safety checks are necessary to ensure that the risk of ignition is minimised. For repair to the refrigerating system, the following precautions shall be complied with prior to conducting work on the system.

6-2 Work procedure

Work shall be undertaken under a controlled procedure so as to minimise the risk of flammable gas or vapour being present while the work is being performed.

6-3 General work area

- All maintenance staff and others working in the local area shall be instructed on the nature of work being carried out. Work in confined spaces shall be avoided.
- The area around the workspace shall be sectioned off. Ensure that the conditions within the area have been made safe by control of flammable material.

6-4 Checking for presence of refrigerant

- The area shall be checked with an appropriate refrigerant detector prior to and during work, to ensure the technician is aware of potentially flammable atmospheres.

- Ensure that the leak detection equipment being used is suitable for use with flammable refrigerants, i.e. non-sparking, adequately sealed or intrinsically safe.

6-5 Presence of fire extinguisher

- If any hot work is to be conducted on the refrigeration equipment or any associated parts, appropriate fire extinguishing equipment shall be available to hand.

- Have a dry powder or CO₂ fire extinguisher adjacent to the charging area.

6-6 No ignition sources

- No person carrying out work in relation to a refrigeration system which involves exposing any pipe work that contains or has contained flammable refrigerant shall use any sources of ignition in such a manner that it may lead to the risk of fire or explosion.

- All possible ignition sources, including cigarette smoking, should be kept sufficiently far away from the site of installation, repairing, removing and disposal, during which flammable refrigerant can possibly be released to the surrounding space.

- Prior to work taking place, the area around the equipment is to be surveyed to make sure that there are no flammable hazards or ignition risks. "No Smoking" signs shall be displayed.

6-7 Ventilated area

- Ensure that the area is in the open or that it is adequately ventilated before breaking into the system or conducting any hot work.

- A degree of ventilation shall continue during the period that the work is carried out.

- The ventilation should safely disperse any released refrigerant and preferably expel it externally into the atmosphere.

6-8 Checks to the refrigeration equipment

- Where electrical components are being changed, they shall be fit for the purpose and to the correct specification.

- At all times the manufacturer's maintenance and service guidelines shall be followed. If in doubt consult the manufacturer's technical department for assistance.

- The following checks shall be applied to installations using flammable refrigerants:

- The charge size is in accordance with the room size within which the refrigerant containing parts are installed;
- The ventilation machinery and outlets are operating adequately and are not obstructed;
- If an indirect refrigerating circuit is being used, the secondary circuit shall be checked for the presence of refrigerant;
- Marking to the equipment continues to be visible and legible. Markings and signs that are illegible shall be corrected;
- Refrigeration pipe or components are installed in a position where they are unlikely to be exposed to any substance which may corrode refrigerant containing components, unless the components are constructed of materials which are inherently resistant to being corroded or are suitably protected against being so corroded.

6-9 Checks to electrical devices

- Repairs and maintenance to electrical components shall include initial safety checks and component inspection procedures.

- If a fault exists that could compromise safety, then no electrical supply shall be connected to the circuit until it is satisfactorily dealt with.

SAFETY PRECAUTIONS

- If the fault cannot be corrected immediately but it is necessary to continue operation, an adequate temporary solution shall be used.
- This shall be reported to the owner of the equipment so all parties are advised.
- Initial safety checks shall include:
 - That capacitors are discharged: this shall be done in a safe manner to avoid possibility of sparking;
 - That there no live electrical components and wiring are exposed while charging, recovering or purging the system;
 - That there is continuity of earth bonding.

7. Repairs to sealed components

- During repairs to sealed components, all electrical supplies shall be disconnected from the equipment being worked upon prior to any removal of sealed covers, etc.
- If it is absolutely necessary to have an electrical supply to equipment during servicing, then a permanently operating form of leak detection shall be located at the most critical point to warn of a potentially hazardous situation.
- Particular attention shall be paid to the following to ensure that by working on electrical components, the casing is not altered in such a way that the level of protection is affected.
- This shall include damage to cables, excessive number of connections, terminals not made to original specification, damage to seals, incorrect fitting of glands, etc.
- Ensure that apparatus is mounted securely.
- Ensure that seals or sealing materials have not degraded such that they no longer serve the purpose of preventing the ingress of flammable atmospheres.
- Replacement parts shall be in accordance with the manufacturer's specifications.

NOTE: The use of silicon sealant may inhibit the effectiveness of some types of leak detection equipment. Intrinsically safe components do not have to be isolated prior to working on them.

8. Repair to intrinsically safe components

- Do not apply any permanent inductive or capacitance loads to the circuit without ensuring that this will not exceed the permissible voltage and current permitted for the equipment in use.
- Intrinsically safe components are the only types that can be worked on while live in the presence of a flammable atmosphere. The test apparatus shall be at the correct rating.
- Replace components only with parts specified by the manufacturer.
- Other parts may result in the ignition of refrigerant in the atmosphere from a leak.

9. Cabling

- Check that cabling will not be subject to wear, corrosion, excessive pressure, vibration, sharp edges or any other adverse environmental effects.
- The check shall also take into account the effects of aging or continual vibration from sources such as compressors or fans.

10. Detection of flammable refrigerants

- Under no circumstances shall potential sources of ignition be used in the searching for or detection of refrigerant leaks.
- A halide torch (or any other detector using a naked flame) shall not be used.

11. Leak detection methods

- The following leak detection methods are deemed acceptable for systems containing flammable refrigerants:
 - Electronic leak detectors shall be used to detect flammable refrigerants, but the sensitivity may not be adequate, or may need re-calibration. (Detection equipment shall be calibrated in a refrigerant-free area.)
 - Ensure that the detector is not a potential source of ignition and is suitable for the refrigerant used.
 - Leak detection equipment shall be set at a percentage of the LFL of the refrigerant and shall be calibrated to the refrigerant employed and the appropriate percentage of gas (25 % maximum) is confirmed.
 - Leak detection fluids are suitable for use with most refrigerants but the use of detergents containing chlorine shall be avoided as the chlorine may react with the refrigerant and corrode the copper pipe-work.
 - If a leak is suspected, all naked flames shall be removed/ extinguished.
 - If a leakage of refrigerant is found which requires brazing, all of the refrigerant shall be recovered from the system, or isolated (by means of shut off valves) in a part of the system remote from the leak.
 - Oxygen free nitrogen (OFN) shall then be purged through the system both before and during the brazing process.

12. Removal and evacuation

- When breaking into the refrigerant circuit to make repairs- or for any other purpose - conventional procedures shall be used.
- However, it is important that best practice is followed since flammability is a consideration.
- The following procedure shall be adhered to:
 - Remove refrigerant;
 - Purge the circuit with inert gas;
 - Evacuate;
 - Purge again with inert gas;
 - Open the circuit by cutting or brazing.
- The refrigerant charge shall be recovered into the correct recovery cylinders.
- The system shall be "flushed" with OFN to render the unit safe.
- This process may need to be repeated several times.
- Compressed air or oxygen shall not be used for this task.
- Flushing shall be achieved by breaking the vacuum in the system with OFN and continuing to fill until the working pressure is achieved, then venting to atmosphere, and finally pulling down to a vacuum.
- This process shall be repeated until no refrigerant is within the system. When the final OFN charge is used, the system shall be vented down to atmospheric pressure to enable work to take place.

SAFETY PRECAUTIONS

- This operation is absolutely vital if brazing operations on the pipe-work are to take place.
- Ensure that the outlet for the vacuum pump is not close to any ignition sources and there is ventilation available.

13. Charging procedures

- In addition to conventional charging procedures, the following requirements shall be followed:
 - Ensure that contamination of different refrigerants does not occur when using charging equipment.
 - Hoses or lines shall be as short as possible to minimise the amount of refrigerant contained in them.
 - Cylinders shall be kept upright.
 - Ensure that the refrigeration system is earthed prior to charging the system with refrigerant.
 - Label the system when charging is complete (if not already).
 - Extreme care shall be taken not to overfill the refrigeration system.
- Prior to recharging the system it shall be pressure tested with OFN.
- The system shall be leak tested on completion of charging but prior to commissioning.
- A follow up leak test shall be carried out prior to leaving the site.

14. Decommissioning

- Before carrying out this procedure, it is essential that the technician is completely familiar with the equipment and all its detail.
- It is recommended good practice that all refrigerants are recovered safely.
- Prior to the task being carried out, an oil and refrigerant sample shall be taken in case analysis is required prior to re-use of reclaimed refrigerant. It is essential that electrical power is available before the task is commenced.
 - a) Become familiar with the equipment and its operation.
 - b) Isolate system electrically.
 - c) Before attempting the procedure ensure that:
 - Mechanical handling equipment is available, if required, for handling refrigerant cylinders;
 - All personal protective equipment is available and being used correctly;
 - The recovery process is supervised at all times by a competent person;
 - Recovery equipment and cylinders conform to the appropriate standards.
 - d) Pump down refrigerant system, if possible.
 - e) If a vacuum is not possible, make a manifold so that refrigerant can be removed from various parts of the system.
 - f) Make sure that cylinder is placed on a scale before recovery takes place.
 - g) Start the recovery machine and operate in accordance with manufacturer's instructions.
 - h) Do not overfill cylinders. (No more than 80 % volume liquid charge).
 - i) Do not exceed the maximum working pressure of the cylinder, even temporarily.
 - j) When the cylinders have been filled correctly and the process completed, make sure that the cylinders and the equipment are removed from site promptly and all isolation

valves on the equipment are closed off.

k) Recovered refrigerant shall not be charged into another refrigeration system unless it has been cleaned and checked.

15. Labeling

- Equipment shall be labeled stating that it has been decommissioned and emptied of refrigerant.
- The label shall be dated and signed.
- Ensure that there are labels on the equipment stating the equipment contains flammable refrigerant.





16. Recovery

- When removing refrigerant from a system, either for servicing or decommissioning, it is recommended good practice that all refrigerants are removed safely.
- When transferring refrigerant into cylinders, ensure that only appropriate refrigerant recovery cylinders are employed.
- Ensure that the correct number of cylinders for holding the total system charge is available.
- All cylinders to be used are designated for the recovered refrigerant and labeled for that refrigerant (i.e. special cylinders for the recovery of refrigerant).
- Cylinders shall be complete with pressure relief valve and associated shutoff valves in good working order.
- Empty recovery cylinders are evacuated and, if possible, cooled before recovery occurs.
- The recovery equipment shall be in good working order with a set of instructions concerning the equipment that is at hand and shall be suitable for the recovery of flammable refrigerants.
- In addition, a set of calibrated weighing scales shall be available and in good working order.
- Hoses shall be complete with leak-free disconnect couplings and in good condition.
- Before using the recovery machine, check that it is in satisfactory working order, has been properly maintained and that any associated electrical components are sealed to prevent ignition in the event of a refrigerant release.
- Consult the manufacturer if in doubt.
- The recovered refrigerant shall be returned to the refrigerant supplier in the correct recovery cylinder, and the relevant Waste Transfer Note arranged.
- Do not mix refrigerants in recovery units and especially not in cylinders.
- If compressors or compressor oils are to be removed, ensure that they have been evacuated to an acceptable level to make certain that flammable refrigerant does not remain within the lubricant.
- The evacuation process shall be carried out prior to returning the compressor to the suppliers.
- Only electric heating to the compressor body shall be employed to accelerate this process.
- When oil is drained from a system, it shall be carried out safely.

SAFETY PRECAUTIONS

- When moving or relocating the air conditioner, consult experienced service technicians for disconnection and reinstallation of the unit.
- Do not place any other electrical products or household belongings under indoor unit or outdoor unit. Condensation dripping from the unit might get them wet, and may cause damage or malfunction of your property.
- Do not use means to accelerate the defrosting process or to clean, other than those recommended by the manufacturer.
- The appliance shall be stored in a room without continuously operating ignition sources (for example, open flames, an operating gas appliance or an operating electric heater).
- Do not pierce or burn.
- Be aware R32 refrigerant is colourless and odourless.
- To keep ventilation openings clear of obstruction.
- The appliance shall be stored in a well-ventilated area where the room size corresponds to the room area as specified for operation.
- The appliance shall be stored in a room without continuously operating open flames (for example an operating gas appliance) and ignition sources (for example an operating electric heater).
- Any person who is involved with working on or breaking into a refrigerant circuit should hold a current valid certificate from an industry-accredited assessment authority, which authorises their competence to handle refrigerants safely in accordance with an industry recognised assessment specification.
- Servicing shall only be performed as recommended by the equipment manufacturer.
- Maintenance and repair requiring the assistance of other skilled personnel shall be carried out under the supervision of the person competent in the use of flammable refrigerants.
- Appliance shall be installed, operated and stored in a room with a floor area greater than 10m².
- The pipe-work shall be compliant with natural gas regulations.
- The maximum refrigerant charge amount is 2.5kg. The specific refrigerant charge is based on the nameplate of the outdoor unit.
- Mechanical connectors used indoors shall comply with ISO 14903. When mechanical connectors are reused indoors, the flare part shall be renewed. When flared joints are reused indoors, the flare part shall be re-fabricated.
- The installation of pipe-work shall be kept to a minimum.
- Mechanical connections shall be accessible for maintenance purposes.

Explanation of symbols displayed on the unit

	WARNING	Indicates this appliance uses a flammable refrigerant. If the refrigerant is leaked and exposed to an external ignition source, there is a risk of fire.
	CAUTION	Indicates the operation manual should be read carefully.
	CAUTION	Indicates a service personnel should be handling this equipment with reference to the installation manual
	CAUTION	Indicates information is available such as the operating manual or installation manual.

INSTALLATION INSTRUCTIONS

INSTALLATION DIAGRAM

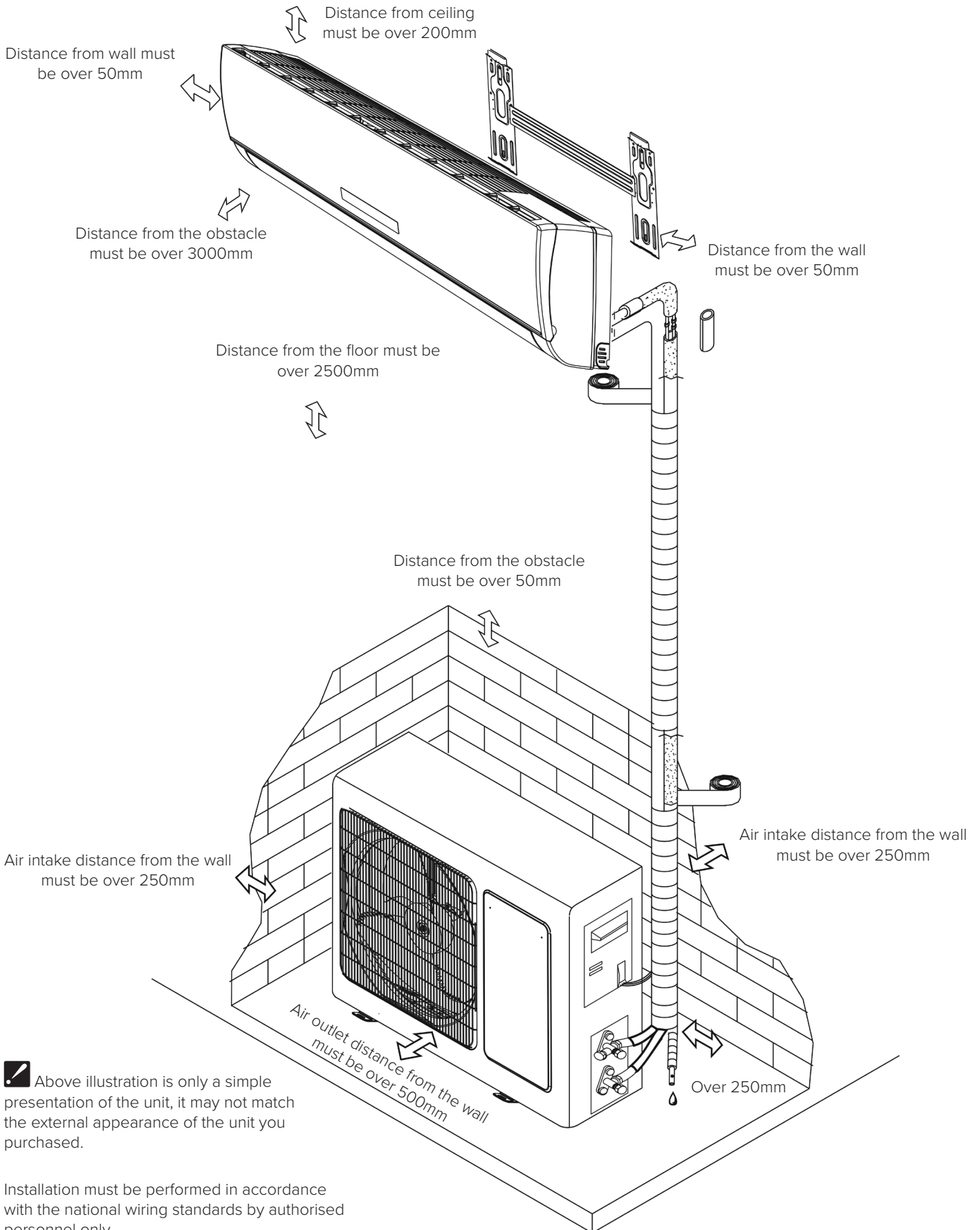

INSTALLATION INSTRUCTIONS

INDOOR UNIT

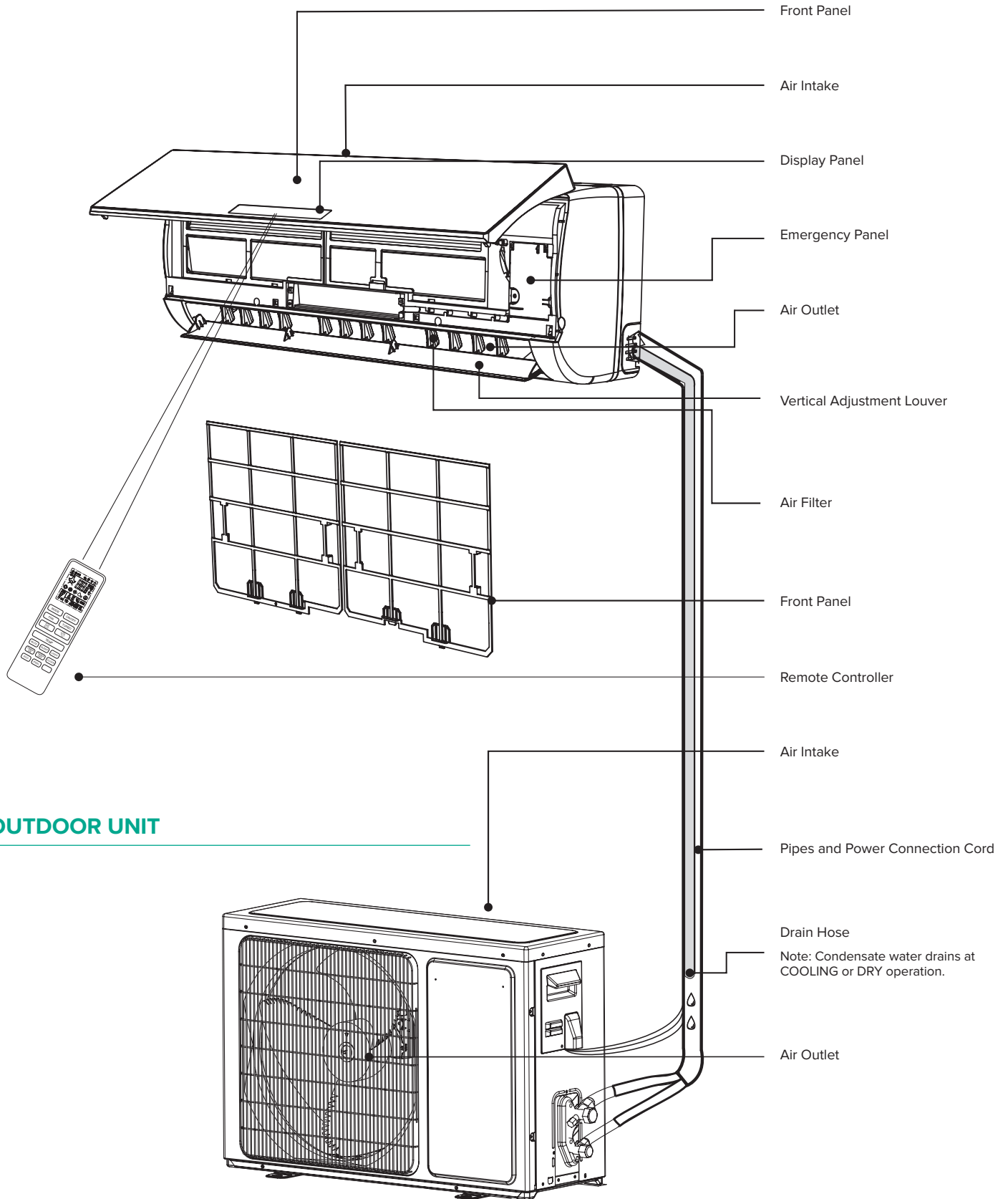

OUTDOOR UNIT

 The figures in this manual are based on a standard model. Therefore, the shape may differ from that of the air conditioner you have selected.

DISPLAY INTRODUCTION

TEMPERATURE INDICATOR **88**

Display set temperature.

RUNNING INDICATOR

Lights up when the AC is running.

Flashes during defrosting.

TIMER INDICATOR

Lights up during set time.

SLEEP INDICATOR

Lights up in sleep mode.

EMERGENCY BUTTON

To let the AC run or stop by pressing the button.

 The symbols may be different from these models, but the functions are similar.

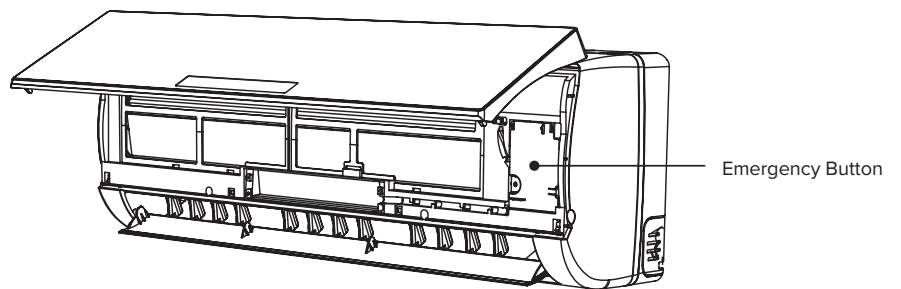
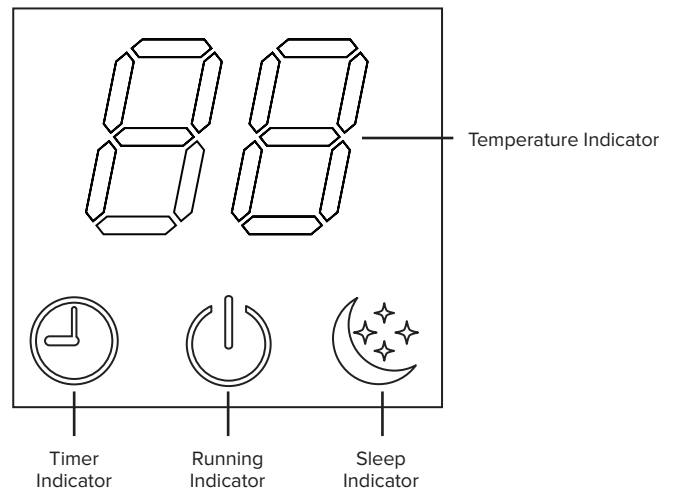

REMOTE CONTROLLER

1. ON/OFF

The appliance will turn on or turn off if you press this button.

2. MODE

Press this button to select the operation mode.

3. FAN

Select fan speed from auto, high, medium or low.

4/5. TEMP

Adjust the room temperature and the timer.

5+7. 8°C HEAT (optional)

Press these buttons at the same time for 3 seconds to stop or start 8°C Heat mode.

6. TURBO

Start or stop the fast cooling/heating. Fast cooling operates at high fan speed with 16°C (61°F) set temp automatically. Fast heating operates at auto fan speed with 30°C (86°F) set temp automatically.

7. SWING ⇅

Stop or start vertical adjustment louver swinging and set the desired up/down airflow direction.

8. SLEEP

Set up or cancel SLEEP mode.

9. LIGHT

Pressing this button will turn off all the displays on the indoor unit.

10. CLOCK

Set the current time.

11/12. TIMER ON/OFF

Set or cancel the TIMER operation.

11+12. LOCK

Press these buttons at the same time for 3 seconds to stop or start LOCK operation.

13. ECO

Set or cancel economy mode operation.

14. SWING ⇄ (Feature not available on all models)

Stop or start horizontal adjustment louver swinging and set the desired up/down airflow direction.

15. MUTE

Pressing the MUTE button once activates the MUTE function, and pressing it again deactivates it. This button is used to enable the Clean mode operation.

16. IFEEL

In IFEEL mode, the air conditioner functions according to the temperature sensor located within the remote control, rather than relying on the sensor in the air conditioning unit. To make the most of IFEEL mode, position the remote control where the indoor unit can receive its signal effectively. To activate or deactivate IFEEL mode, press and hold this button for at least 5 seconds.

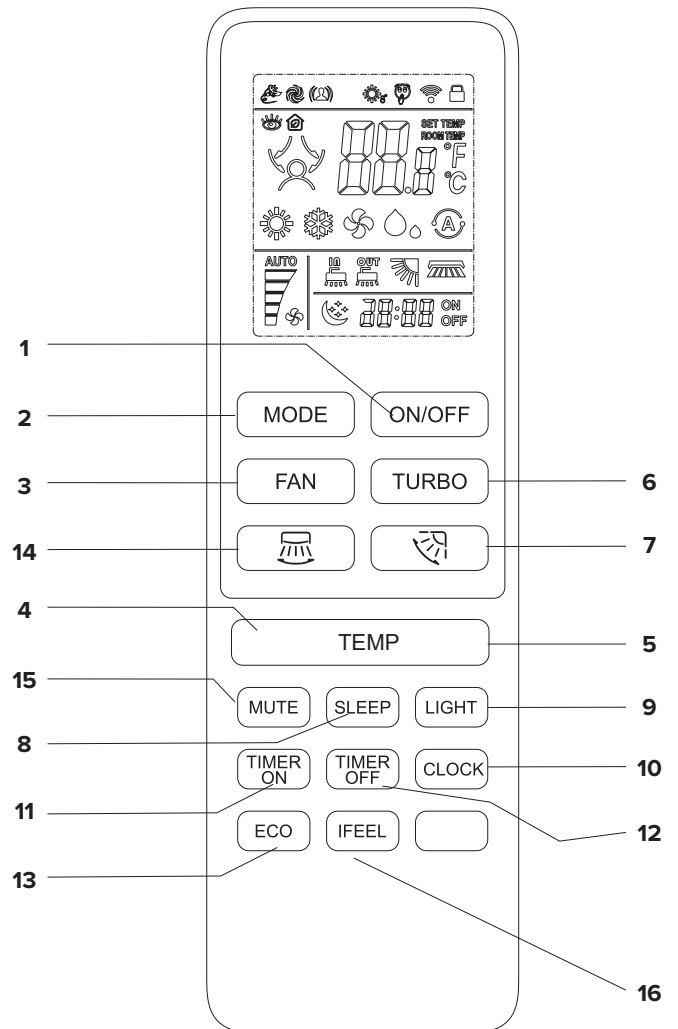

	Cooling indicator		Airflow up and down indicator
	Dry indicator		Smart indicator
	Fan only indicator		Sleep indicator
	Heating indicator		8°C Heat indicator
	Turbo indicator		Economy indicator
	Airflow left and right indicator		Ifeel
	Auto fan speed		Signal transmit
	High fan speed		Display set timer
	Medium fan speed		Display current time
	Low fan speed		Display temperature
	Mute indicator		Lock

NOTE: Each mode and relevant function will be further specified in following pages.

REMOTE CONTROLLER

HOW TO INSERT THE BATTERIES

1. Remove the battery cover according to the arrow direction.
2. Insert new batteries making sure that the (+) and (-) of battery are matched correctly.
3. Reattach the cover by sliding it back into position.

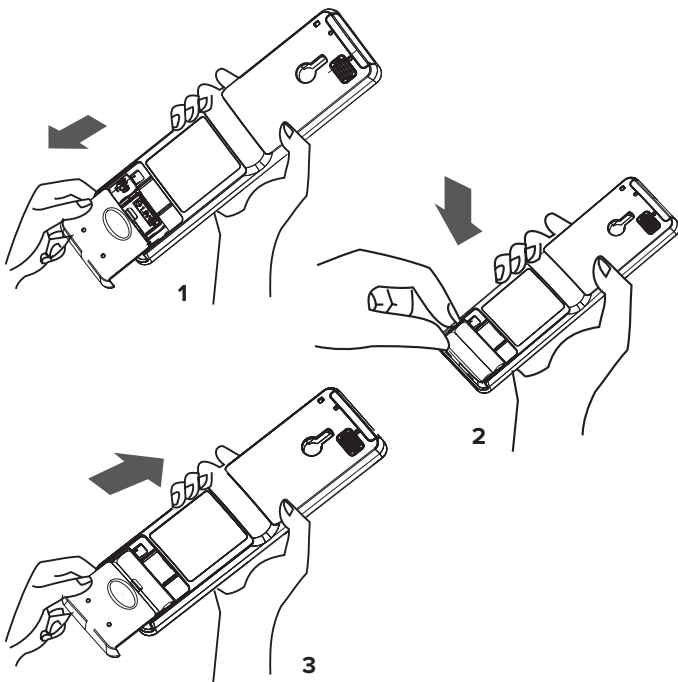

NOTE: Use 2 LR03 AAA (1.5 volt) batteries. Do not use rechargeable batteries. Replace batteries when the display begins to dim.

HOW TO USE

To use the air conditioner, point the remote controller towards the signal receptor. The remote controller can operate the air conditioner from a distance of up to 7 meters when directed at the indoor unit's signal receptor.

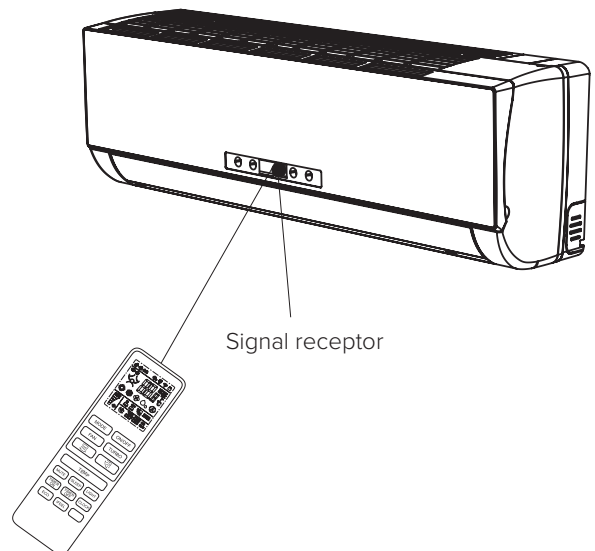

⚠ For appropriate signal transmission between remote controller and indoor unit, keep the signal receiver away from the following items:

- Direct sunlight or other strong lights or heat
- Flat panel television screen or other electrical appliances that react to the remote controller

Additionally, the air conditioner will not operate if curtains, doors or other materials block the signals from the remote controller to the indoor unit. If the signal may not be transmitted properly, either move these materials or consult your local dealer.

STORAGE AND USE OF THE REMOTE CONTROLLER

The remote controller may be stored mounted on a wall with a holder.

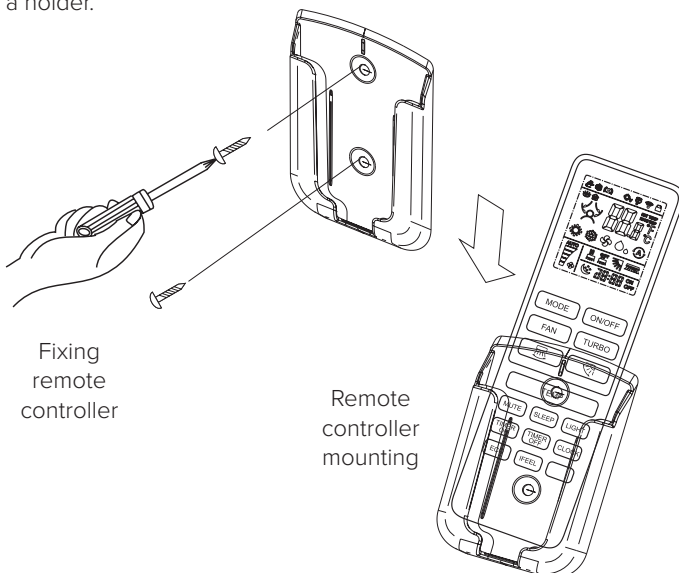

NOTE: The remote control holder is optional.

REMOTE CONTROLLER OPERATION INSTRUCTIONS

OPERATION MODES

1. SELECTING MODE

Each time the "MODE" button is pressed, the operation mode is changed in sequence:

COOLING → DRY → FAN ONLY → HEATING → AUTO
↑

2. FAN MODE

Each time the "FAN" button is pressed, the fan speed is changed in sequence:

Auto → Higher → High → Medium → Low → Lower
↑

At "FAN ONLY" mode, only "Higher", "High", "Medium", "Low" and "Lower" are available.

At "DRY" mode, Fan speed is set at "Auto" automatically, "FAN" button is ineffective in this case.

3. SETTING TEMPERATURE

"+" Press once to raise temperature setting by 1°C

"-" Press once to raise temperature setting by 1°C

Range of available set temperature	
HEATING, COOLING	16°C~30°C

NOTE: Press and hold the **MODE** and **- TEMP** together for 3 seconds to alternate the temperature display between the °C and °F setting.

4. TURNING ON

Press ON/OFF button, when the appliance receives the signal, the RUN indicator of the indoor unit lights up.

SWING, SMART, TIMER ON, TIMER OFF, CLOCK, SLEEP, and NANOE operation modes will be specified in the following pages.

• Changing modes during operation, sometimes the unit does not respond at once. Wait 3 minutes.

• During heating operation, air flow is not discharged at the beginning. After 2-5 minutes, the air flow will be discharged until temperature of indoor heat exchanger rises.

• Wait 3 minutes before restarting the appliance.

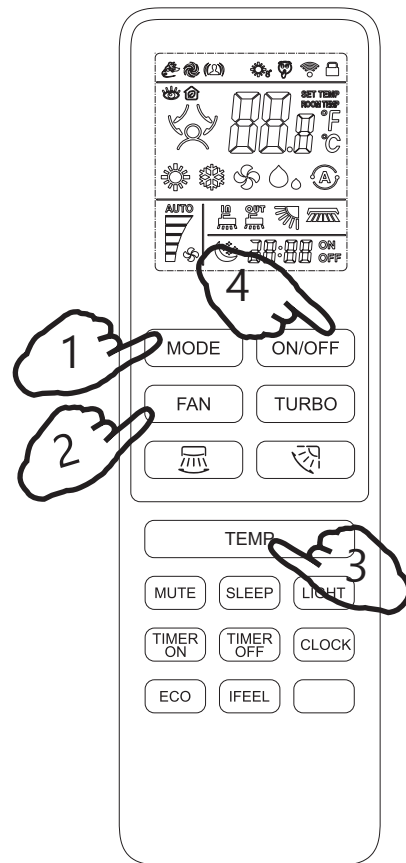

REMOTE CONTROLLER OPERATION INSTRUCTIONS

AIRFLOW DIRECTION CONTROL

Vertical airflow (Horizontal airflow) is automatically adjusted to a certain angle in accordance with the operation mode after turning on the unit.

NOTE: Horizontal swing  not available on all models.

Operation mode	Direction of airflow
COOLING, DRY	Horizontal
HEATING, FAN ONLY	Downward

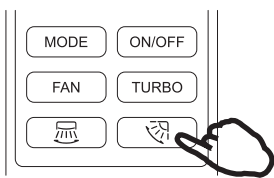

The direction of airflow can be also adjusted to your own requirement by pressing the "SWING" button of the remote controller.

VERTICAL AIRFLOW CONTROL (with remote controller)

Using remote controller to set various angles of flow or specific angle as you like.

Swinging airflow

Pressing  button once, the vertical adjustment louver will swing up and down automatically.

Desired direction airflow

Pressing the  button again when the louvers swing to a suitable angle as desired.

HORIZONTAL AIRFLOW CONTROL (with remote controller)

Using remote controller to set various angles of flow or specific angle as you like.

Swinging airflow

Pressing the  button once, the horizontal adjustment louver will swing left and right automatically.

Desired direction airflow

Pressing the  button again when the louvers swing to a suitable angle as desired.

NOTE: If the unit doesn't have four ways airflow function you can adjust horizontal airflow yourself.

 Do not turn the vertical adjustment louvers manually, otherwise malfunction may occur. If that happens, turn off the unit first and cut off the power supply, then restore power supply again.

 It is better not to let the vertical adjustment louver tilt downward for a long time at COOLING or DRY mode to prevent condensed water from dripping.

CLOCK BUTTON

HOW TO SET SMART MODE

You can adjust the real time by pressing CLOCK button, then using "+" and "-" buttons to get the correct time, press CLOCK button again the real time is set.



TIMER MODE

It is convenient to set the timer on with TIMER ON button when you go out in the morning to achieve a comfortable room temperature at the time you get home.

You can also set timer off at night to enjoy a good sleep.

HOW TO SET TIMER ON

TIMER ON button can be used to set the timer programming as wished in order to switch on the appliance at your desired time.

1. Press TIMER ON button, "ON 12:00" flashes on the LCD, then you can press the "+" or "-" buttons to select your desired time for appliance on.

 Increase

 Decrease

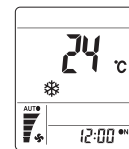

Press the "+" or "-" button once to increase or decrease the time setting by 1 minute.

Press the "+" or "-" button 2 seconds to increase or decrease the time setting minutes by 10.

Press the "+" or "-" button for a longer time to increase or decrease the time by 1 hour.

NOTE: If you don't set the time in 10 seconds after you press TIMER ON button, the remote controller will exit the TIMER ON mode automatically.

2. When your desired time displayed on LCD, press the TIMER ON button and confirm it.

"ON" stops flashing.

The TIMER indicator on the indoor unit lights up.

3. After the set timer displayed for 5 seconds the clock will be displayed on the LCD of the remote controller instead of set timer.

HOW TO CANCEL TIMER ON

Press the TIMER ON button again, the indicator disappears, the TIMER ON mode has been canceled.

NOTE: It is similar to set TIMER OFF, you can make the appliance switch off automatically at your desired time.

REMOTE CONTROLLER OPERATION INSTRUCTIONS

SLEEP MODE

SLEEP mode can be set in COOLING, HEATING or DRYING mode.

This function gives you a more comfortable environment for sleep.

- The appliance will stop operation automatically after operating for 8 hours.
- Fan speed is automatically set at low speed.

HOW TO SET SLEEP MODE

Each time the **SLEEP** button is pressed the operation mode is changed in sequence:

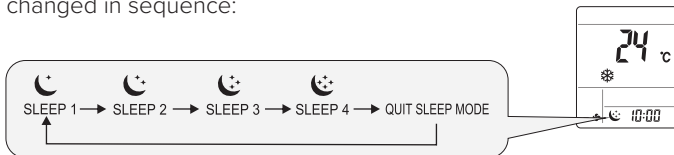

SLEEP mode 1

- Set temperature will rise by 2°C at most if the appliance operates in cooling mode for 2 hours constantly, then keeps steady.
- Set temperature will decrease by 2°C at the most if the appliance operates in heating mode for 2 hours constantly, then keeps steady.

SLEEP mode 2

- Set temperature will rise by 2°C if the appliance operates in cooling mode for 2 hours constantly, decrease by 1°C after 6 hours, then decrease by 1°C after 7 hours.

SLEEP mode 3

- Set temperature will rise by 1°C if the appliance operates in cooling mode for 1 hour, rise by 2°C after 2 hours, then decrease by 2°C after 6 hours, decrease by 1°C after 7 hours.
- Set temperature will decrease by 2°C if the appliance operates in heating mode for 1 hour, decrease by 2°C after 2 hours, then rise by 2°C after 6 hours, rise by 2°C after 7 hours.

SLEEP mode 4

- Set temperature will keep steady.

NOTE: Press SLEEP button in TURBO mode, exit the TURBO mode not respond to sleep mode operation.

NOTE: SLEEP modes are not available for FAN ONLY and AUTO mode.

NOTE: In SLEEP mode press SLEEP, ON/OFF, FAN, TURBO, MODE or ECO buttons to cancel SLEEP mode.

NOTE: In SLEEP mode or HEATING mode it will exit the SLEEP mode when pressing the combination buttons to enter the 8°C HEAT mode.

8°C HEAT MODE

In HEATING mode, press **HEAT** and **TEMP** buttons together for 3 seconds to start 8°C HEAT mode.

In 8°C HEAT mode, the fan speed is set at "AUTO" automatically. The icon will appear on the LCD.

If pressing any button, other than ON TIMER, OFF TIMER, DIMMER, IFEEL and SWING, 8°C HEAT function will be turned off and the  icon will disappear.

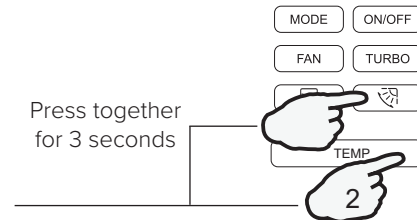

NOTE: In 8°C HEAT mode, the default temperature is set 8°C. 8°C HEAT mode can be set only when the air conditioner works in HEATING mode.

TURBO MODE

TURBO mode is used to start or stop fast cooling when the unit is on.

TURBO mode can be set when the appliance is in operation or energized.

In TURBO mode, you can set airflow direction or timer.

HOW TO SET TURBO MODE

Press TURBO button at the cooling, fan only or dry mode. Result - At high fan speed the set temperature automatically to 16°C.

Press TURBO button at the heating mode .

Result - At AUTO fan speed the set temperature automatically to 30°C.

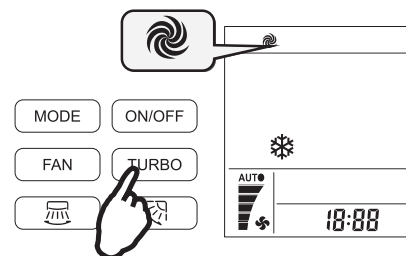

HOW TO CANCEL TURBO MODE

Press TURBO , MODE, FAN, ON/OFF, SLEEP, TURBO or MUTE button.

Result - The display return to the original mode. Escape from TURBO mode.

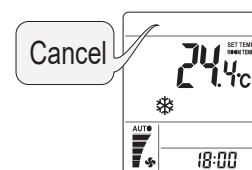

REMOTE CONTROLLER OPERATION INSTRUCTIONS

MUTE MODE

In this mode, the air conditioner will work with low noise performance.

In this mode, you can start the SLEEP mode at the same time.

NOTE:

Press MODE, FAN SPEED, SMART or SUPER button to cancel MUTE mode.

MUTE button is only available in COOLING, HEATING and FAN ONLY mode.



ECO MODE

In this mode, the air conditioner will bring you energy saving performance by lower running currency.

NOTE:

ECONOMY button is ineffective in SMART and SUPER mode. SMART and SUPER buttons are not available in ECONOMY mode.

Press ON/OFF, MODE, TEMP ±, FAN SPEED, SLEEP, QUIET or ECONOMY button to cancel ECONOMY mode.



IFEEL FUNCTION

The temperature sensor built in remote controller is activated. It can sense its surrounding temperature, and transmit the signal back the unit, the unit can adjust the temperature so as to provide maximum comfort.

NOTE:

Advice to put the remote controller in the place where the indoor unit receive signal easily.

Advice to cancel the IFEEL mode so as to save energy when stopping the air conditioner.



CLEAN FUNCTION

When the air conditioner is in standby, and the mode of the remote controller is in Cooling or Dry press the MUTE button for 5 seconds to start the Clean mode, then the  indicator will display on the LCD.

Clean mode is ineffective in TURBO mode.

Press ON/OFF or MODE button can exit the Clean mode, then the  indicator will disappear.

After the clean process finish, the air conditioner will return to Cooling or Dry as preset, while the  indicator on remote controller will display for about 10 mins.



LOCK FUNCTION

Press TIME ON and TIME OFF buttons together for 3 seconds to start LOCK function.

The  icon will appear on the LCD.

Press TIME ON and TIME OFF buttons together for 3 seconds again to stop LOCK function.

The  icon will disappear from the LCD.



Press together
for 3 seconds

INSTALLATION INSTRUCTIONS

SELECT THE INSTALLATION LOCATIONS

LOCATION FOR INSTALLING INDOOR UNIT

- Where there are no obstacles near the air outlet and air can be easily blown to every corner.
- Where piping route through the wall can be easily arranged.
- Keep the required space from the unit to the ceiling and wall according to the installation diagram on previous page.
- Where the air filter can be easily removed.
- Keep the unit and remote controller 1 m or more from television, radio etc.
- Keep as far as possible from fluorescent lamps.
- Do not put anything near the air inlet to obstruct it from air intake.
- Install on a wall that is strong enough to bear the weight of the unit.
- Install in a place that will not increase operation noise and vibration.
- Keep away from direct sunlight and heating sources. Do not place flammable materials or combustion apparatuses on top of the unit.

LOCATION FOR INSTALLING OUTDOOR UNIT

- Where it is convenient to install and well ventilated.
- Avoid installing it where flammable gas could leak.
- Keep the required distance apart from the wall.
- The pipe length between indoor and outdoor unit should be not more than 5 meters in factory default status, but it can go up to maximum 15 meters with additional refrigerant charge.
- Keep the outdoor unit away from grease and dirt.
- Avoid installing it where there is a risk of muddy water.
- A fixed base where it is not subject to increased operation noise.
- Where there is not any blockage of the air outlet.
- Avoid installing under direct sunlight, in an aisle or side way, or near heat sources and ventilation fans. Keep away from flammable materials, thick fog, and wet or uneven places.

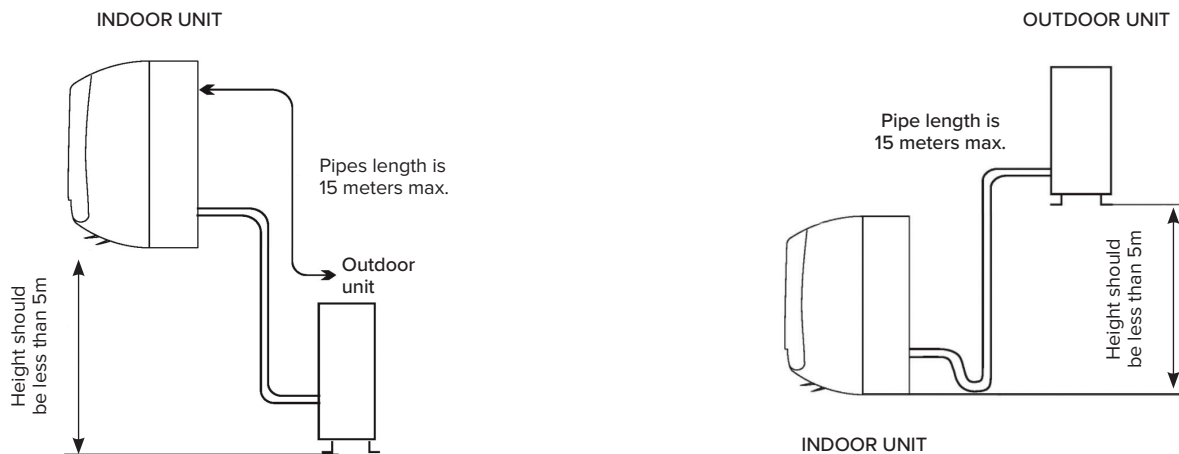

MODEL	Max. allowed pipe length without additional refrigerant (m)	Limit of pipe length (m)	Limit of Elevation Difference H (m)	Required amount of additional refrigerant (g/m)
ACSS25 (2.5Kw)	10	20	5	20
ACSS35 (3.5Kw)	10	25	5	20
ACSS50 (5.0Kw)	20	30	5	30
ACSS72 (7.2Kw)	20	30	5	30

If the height or pipe length is out of the scope of the table, please consult the dealer

INSTALLATION INSTRUCTIONS

INDOOR UNIT INSTALLATION

1. Decide on the install location for the mounting plate according to the indoor unit location and piping direction.

NOTE: It is recommended to install screw anchors for sheet rock, concrete block, brick and such type of wall.

- Keep the mounting plate horizontal with a horizontal level or dropping line.
- Mark the centre of the indoor unit on mounting plate for future reference.

NOTE: The centre of the mounting bracket may not be the centre of the indoor unit.

- Tapping mounting plate to the wall with a minimum of five screws evenly spaced to properly support indoor unit weight.

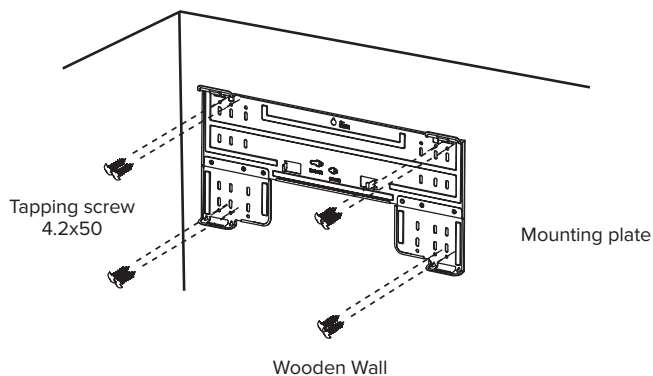
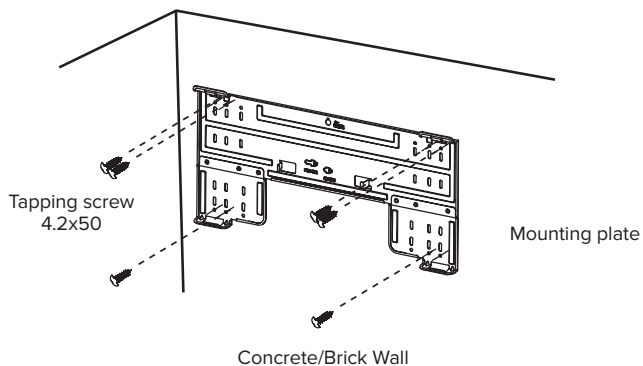

NOTE: The shape of your mounting plate may be different from the one above but the installation method is similar.

NOTE: As the above figure shows the six holes matched with tapping screw on the mounting plate must be used to fix the mounting plate, the others are prepared.

2. DRILL A HOLE FOR PIPE

- Decide on the position of hole for piping according to the location of mounting plate.
- Drill a hole on the wall of about 50mm. The hole should tilt slightly downward toward the outside.
- Install a sleeve through the wall hole to keep the wall clean and tidy.

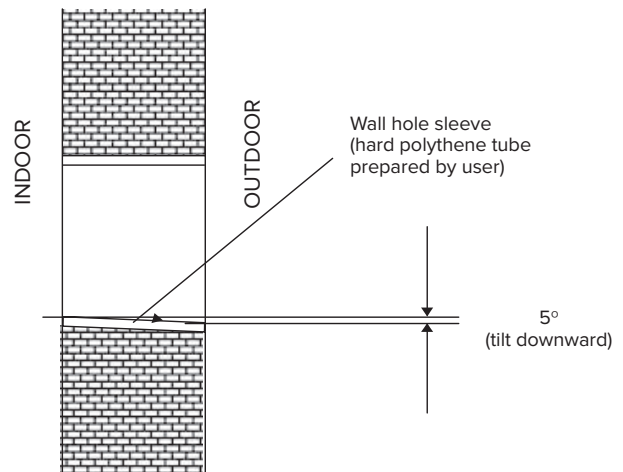

3. INDOOR UNIT PIPE INSTALLATION

- To connect the outdoor unit, you can either pass the liquid and gas pipes along with the cables through the wall hole from the outside, or you can do it from the inside after completing the indoor pipe and cable connections.
- Determine whether to cut off the unloading piece based on the direction of the pipe, as illustrated below.

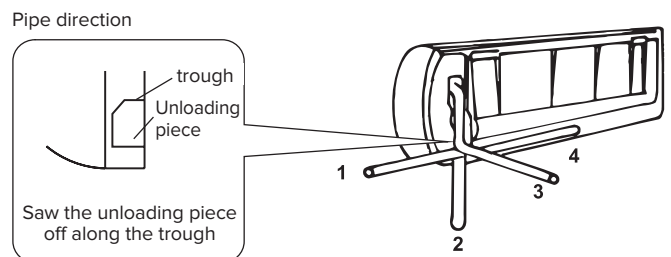

NOTE: When installing the pipe as per 1, 2, or 4, you should cut off the corresponding piece from the indoor unit base.

- After connecting pipe as required install the drain hose. Then connect the power cords. After connecting wrap the pipes, cords and drain hose together with thermal insulation materials.

INSTALLATION INSTRUCTIONS

PIPE JOINTS THERMAL INSULATION:

Wrap the pipe joints with thermal insulation materials and then wrap with a vinyl tape.

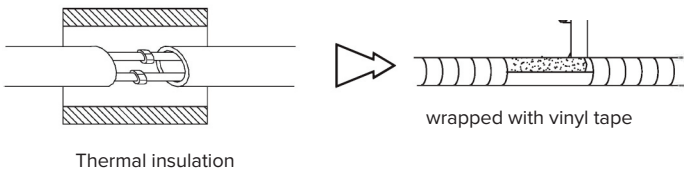

PIPES THERMAL INSULATION:

- Place the drain hose under the pipes.
- Insulation material uses polythene foam over 6mm in thickness.

NOTE: Drain hose is prepared by user.

- Ensure that the drain pipe is oriented downward to facilitate proper drainage flow. Avoid twisting, sticking out, or creating unnecessary bends in the drain pipe. Additionally, refrain from submerging the end of the drain pipe in water.
- If you connect an extension drain hose to the drain pipe, it's important to insulate it thermally when passing it along the indoor unit for better insulation.
- When the pipes are directed to the right, it is essential to thermally insulate and secure the pipes, power cord, and drain pipe onto the back of the unit using a pipe fixer.

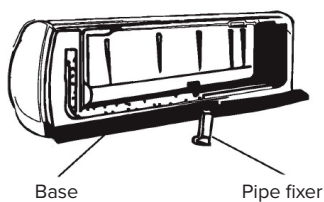
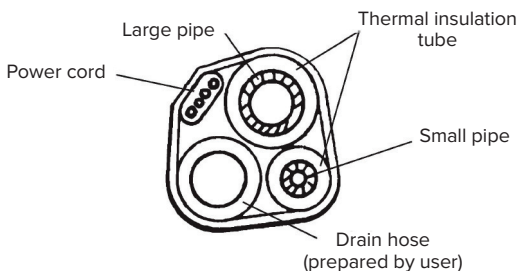

A. Insert the pipe fixer to the slot.

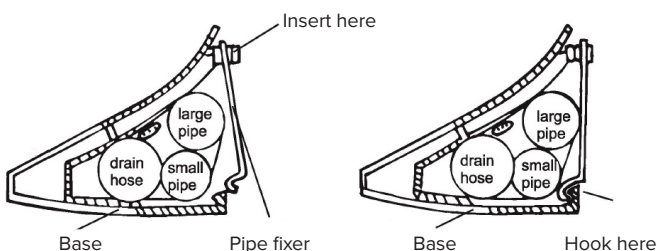

B. Press to hook the pipe fixer onto the base.

PIPING CONNECTION:

- Prior to unscrewing the large and small sealing caps, press the small sealing cap with your finger until the exhaust noise ceases, and then proceed to release your finger before loosening the cap.
- When connecting the indoor unit pipes, use two wrenches. It's crucial to carefully observe the specified torque limits, as indicated below, to prevent any deformation or damage to the pipes, connectors, and flare nuts.
- Start by initially tightening them with your fingers before using the wrenches.

 If you don't hear the exhaust noise, please contact the merchant.

Model	Pipe size	Torque	Nut width	Min. thickness
ACSS25 (2.5Kw) ACSS35 (3.5Kw) ACSS50 (5.0Kw)	Liquid Side (ϕ 6mm)	15~20N.m	17mm	0.5mm
ACSS72 (7.2Kw)	Liquid Side (ϕ 9.53mm)	30~35N.m	22mm	0.6mm
ACSS25 (2.5Kw) ACSS35 (3.5Kw)	Gas Side (ϕ 9.53mm)	30~35N.m	22mm	0.6mm
ACSS50 (5.0Kw)	Gas Side (ϕ 12mm)	50~55N.m	24mm	0.6mm
ACSS72 (7.2Kw)	Gas Side (ϕ 16mm)	60~65N.m	27mm	0.6mm

 **NOTE:** Piping connection should be conducted on the outdoor side!

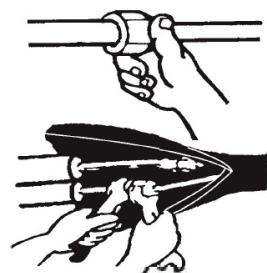
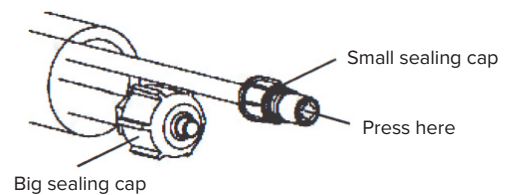

INSTALLATION INSTRUCTIONS

CONNECTING THE CABLE

INDOOR UNIT

Connect the power cord to the indoor unit by attaching the wires individually to the terminals on the control board in accordance with the outdoor unit connection.

NOTE: For some models it may be necessary to remove the cover to connect to the indoor unit terminal.

OUTDOOR UNIT

1. Remove the access door from the unit by loosening the screw. Connect the wires to the terminals on the control board individually as follows.
2. Secure the power cord onto the control board with cable clamp.
3. Reinstall the access door to the original position with the screw.
4. Use a recognised circuit breaker for 7.2Kw model between the power source and the unit. A disconnecting device to adequately disconnect all supply lines must be fitted.

CAUTION:

1. Always ensure there is a dedicated power circuit exclusively for the air conditioner. For wiring instructions, consult the circuit diagram provided on the inside of the access door.
2. Verify that the cable thickness matches the specifications outlined in the power source requirements.
3. Inspect the wires and ensure they are securely fastened after making the cable connections.
4. In areas that are wet or prone to moisture, it is essential to install an earth leakage circuit breaker.

CABLE SPECIFICATIONS

Capacity	Power Cord		Power connecting cord	
	Type	Normal cross section area	Type	Normal cross section area
ACSS25 (2.5Kw) ACSS35 (3.5Kw)	H07RN-F	1.0mm ² x3	H05RN-F	0.75mm ² x4
ACSS50 (5.0Kw)	H07RN-F	1.5mm ² x3	H05RN-F	0.75mm ² x4
ACSS72 (7.2Kw)	H07RN-F	2.5mm ² x3	H05RN-F	0.75mm ² x4

ATTENTION:

The plug must be accessible even after the installation of the appliance in case there is a need to disconnect it. If not possible, connect appliance to a double-pole switching device with contact separation of at least 3 mm placed in an accessible position even after installation.

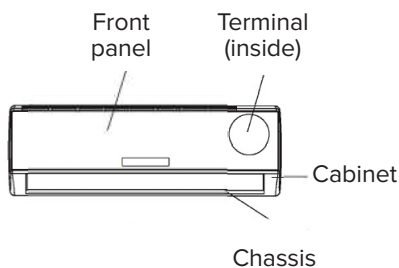

INDOOR UNIT

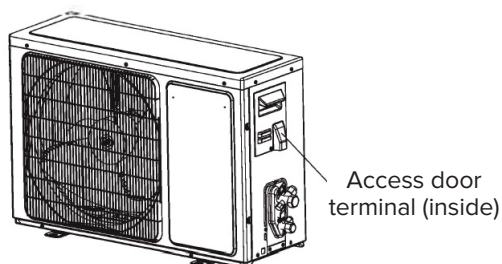

OUTDOOR UNIT

INSTALLATION INSTRUCTIONS

WIRING DIAGRAM

WARNING: Before obtaining access to terminals, all supply circuits must be disconnected.

Make sure that the color of the wires in the outdoor unit and terminal number are the same as those of the indoor unit.

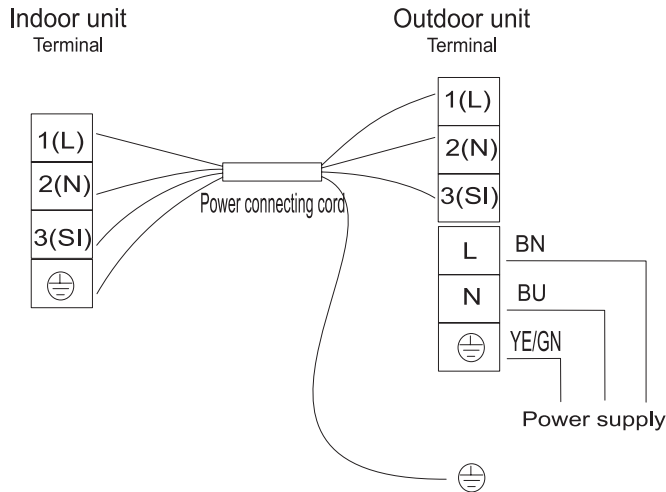

- Connect the DRED device to the DRED terminal on the air conditioner.

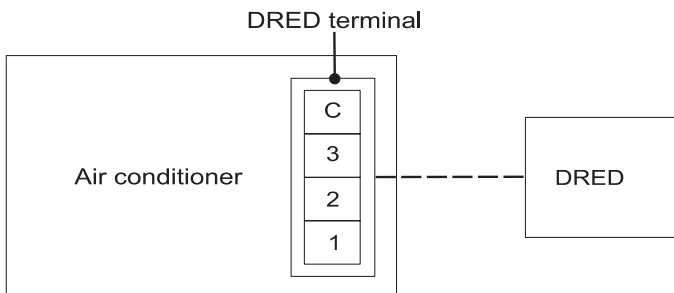

OUTDOOR UNIT INSTALLATION

1. Install Drain Port and Drain Hose.

When the outdoor unit operates in heating mode, condensate drains from it. To avoid disturbing your neighbours and protect the environment, you should install a drain port and a drain hose to channel the condensate water. Simply attach the drain port and rubber washer to the outdoor unit's chassis, and then connect a drain hose to the port as shown in the illustration below.

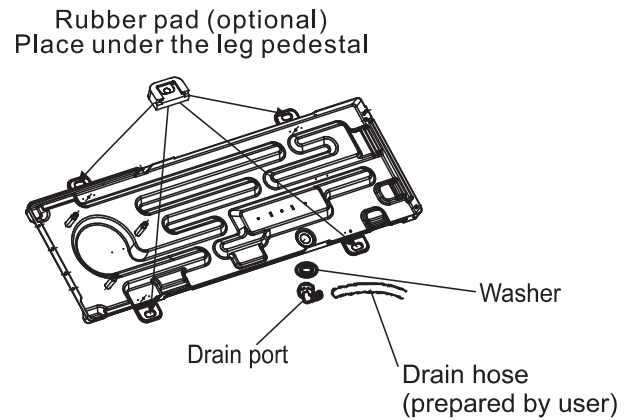

2. Install and fix Outdoor Unit.

Securely attach the object using bolts and nuts to a flat and sturdy surface. If you are mounting it on a wall or roof, ensure that the support structure is securely fastened to prevent any movement caused by intense vibrations or strong winds.

3. Outdoor Unit Piping Connection

- Remove the valve caps from the 2-way and 3-way valve.
- Connect the pipes to the 2-way and 3-way valves separately according to the required torque.

4. Outdoor Unit Cable Connection (see previous).

INSTALLATION INSTRUCTIONS

AIR PURGING

To prevent compressor malfunctions, it's important to remove any moisture-laden air from the refrigeration cycle. This can be done by using a vacuum pump after connecting the indoor and outdoor units, as demonstrated below.

NOTE: To protect the environment, be aware not to discharge the refrigerant to the air directly.

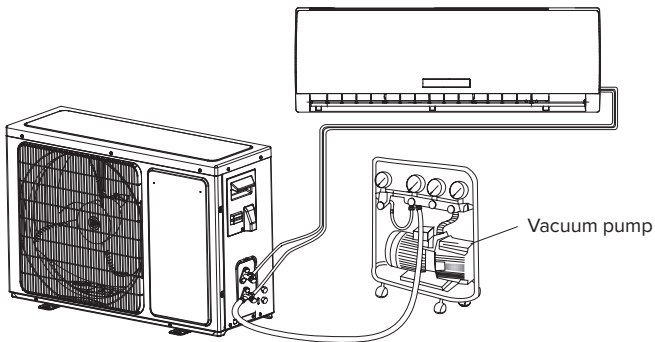

HOW TO PURGE AIR TUBES:

1. Unscrew and remove caps from 2 and 3-way valves.
2. Unscrew and remove cap from service valve.
3. Connect vacuum pump flexible hose to the service valve.
4. Start vacuum pump for 10-15 minutes until reaching a vacuum of 10 mm Hg absolutes.
5. With vacuum pump still running close the low pressure knob on vacuum pump manifold. Then stop the vacuum pump.
6. Open 2-way valve, 1/4 turn, then close it after 10 seconds. Check tightness of all joints using liquid soap or an electronic leak detector.
7. Turn 2 and 3-way valves stem to fully open the valves. Disconnect the flexible vacuum pump hose.
8. Replace and tighten all valve caps.

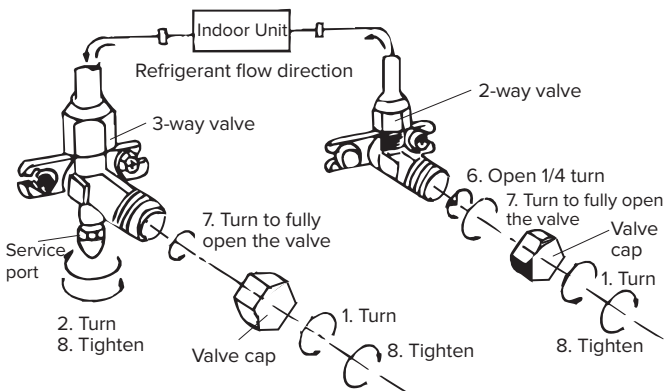

3-WAY VALVE DIAGRAM

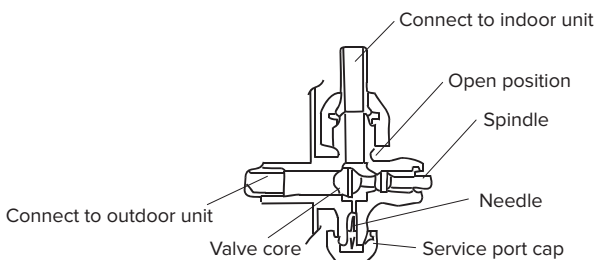

MAINTENANCE

FRONT PANEL MAINTENANCE

1. CUT OFF POWER SUPPLY

Turn off the appliance first before disconnecting from the power supply.

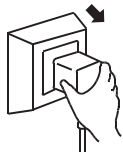

2. REMOVE FRONT PANEL

Grasp position 'a' and pull outward to remove the front panel.

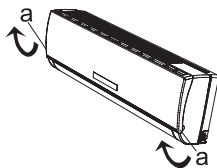

3. WIPE WITH A SOFT DRY CLOTH

Use a soft moist cloth to clean the front panel.



4. NEVER USE VOLATILE SUBSTANCES

Such as gasoline or polishing powder to clean the appliance.



5. NEVER SPRAY WATER ONTO THE INDOOR UNIT

Dangerous electric shock.



4. REINSTALL AND SHUT THE FRONT PANEL

Reinstall and shut the front panel by pressing position 'b' downward.

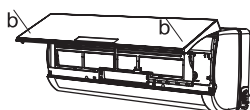

AIR FILTER MAINTENANCE

1. STOP THE APPLIANCE, CUT OFF THE POWER SUPPLY AND REMOVE THE AIR FILTER

1. Open the front panel.
2. Press the handle of the filter gently from the front.
3. Grasp the handle and slide out the filter

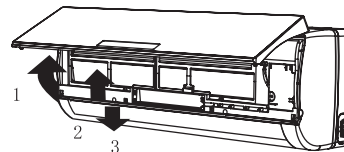

2. CLEAN AND REINSTALL THE AIR FILTER

If there is dirt present, wash it with a solution of detergent in lukewarm water.

After cleaning, dry well in shade.



3. CLOSE THE FRONT PANEL AGAIN

-  Clean the air filter every two weeks if the air conditioner operates in an extremely dusty environment.

IT IS NECESSARY TO CLEAN THE AIR FILTER AFTER USING IT FOR ABOUT 100 HOURS.

OPERATING CONDITION

OPERATING TEMPERATURE

Temperature		Cooling operation	Heating operation	Drying operation
Indoor temperature	max	32°C	27°C	32°C
	min	21°C	7°C	18°C
Outdoor temperature	max	50°C	24°C	43°C
	min	-15°C	-15°C	21°C

NOTE: Optimum performance will be achieved within these operating temperatures. If air conditioner is used outside of the above conditions, the protective device may trip and stop the appliance.

The temperature of some products is allowed beyond the range. In specific situations, please consult the manufacturer. When relative humidity is above 80%, if the air conditioner runs in COOLING or DRY mode with doors and windows opened for a long time, dew may drip down from the outlet.

NOISE POLLUTION

- Install the air conditioner at a place that can bear its weight in order to operate more quietly.
- Install the outdoor unit at a place where the air discharged and the operation noise would not annoy your neighbours.
- Do not place any obstacles in front of the air outlet of the outdoor unit. It could increase the noise level.

FEATURES OF PROTECTOR

1. The protective device will work in the following cases.

- Restarting the unit at once after operation stops or changing mode during operation, you need to wait for 3 minutes.
- Connect to power supply and turn on the unit at once, it may start 20 seconds later.

2. If all operation has stopped, press ON/OFF button again to restart, timer should be set again if it has been canceled.

FEATURES OF HEATING MODE

PREHEAT

At the beginning of the HEATING operation, the airflow from the indoor unit is discharged 2-5 minutes later.



DEFROST

In HEATING operation the appliance will defrost automatically to raise efficiency. This procedure usually lasts 2-10 minutes. During defrosting, fans stop operation.

After defrosting completes, the air conditioner will return to HEATING mode automatically.

TROUBLESHOOTING

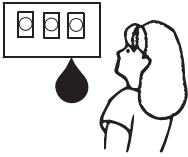
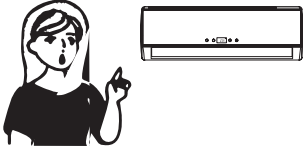
The following cases may not always be a malfunction, please check it before requesting a service.

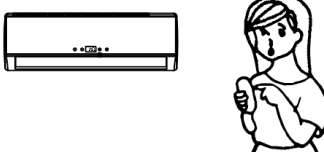
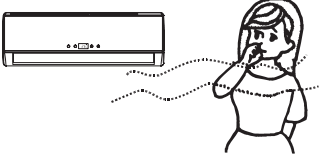
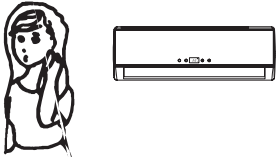
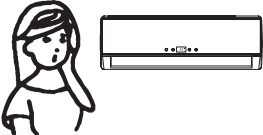
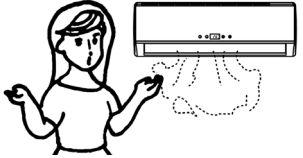
PROBLEM	SOLUTION
<p>Does not run</p> 	<ul style="list-style-type: none"> • The circuit protector or fuse is blown. • Please wait for 3 minutes and start again, the protection device may be preventing unit to work. • If batteries in the remote controller flat. • If it is not properly plugged in.
<p>No cooling or heating air</p> 	<ul style="list-style-type: none"> • Is the air filter dirty? • Are the inlets and outlets of the air conditioner blocked? • Is the temperature set properly?
<p>Ineffective control</p> 	<ul style="list-style-type: none"> • When encountering strong interference, such as excessive static electricity discharge or abnormal power supply voltage, the control system may become ineffective and result in abnormal operation. In such cases, it's advisable to disconnect the power supply and then reconnect it after a brief 2-3 second delay.
<p>Does not operate immediately</p> 	<ul style="list-style-type: none"> • Changing mode during operation will cause a 3 minute delay.
<p>Strange odor</p> 	<ul style="list-style-type: none"> • This odour may come from another source. Check that other odours are not being drawn back into the unit and blown out with the air.
<p>Sound of flowing water</p> 	<ul style="list-style-type: none"> • Caused by the flow of refrigerant in the air conditioner which is normal. • Defrosting sound in heating mode.
<p>Hearing a cracking sound</p> 	<ul style="list-style-type: none"> • The sound may be generated by the expansion or contacting of the front panel due to change of temperature.
<p>Mist spray from outlet</p> 	<ul style="list-style-type: none"> • Mist appears when the room air becomes very cold because of cool air discharged from indoor unit during COOLING or DRY operation mode
<p>The compressor indicator (red) light is on constantly and indoor fan stops</p>	<ul style="list-style-type: none"> • The unit is shifting from heating mode to defrost. The indicator lights will go off within 10 minutes and return to heating mode.

AFTER SALES SERVICE

If your hot water heater can not operate normally, turn off the unit and cut off the power supply at immediately.

Contact your service center or technical department.

WARRANTY INFORMATION

Emerald Energy Pty Ltd warrants this heat pump to the original purchaser.

Emerald Energy Pty Ltd warrants each new heat pump is free from defects in material and workmanship under normal use and service from the date of purchase. 5 years parts, 2 years labour warranty . *Subject to terms and conditions.

This warranty does not cover damage resulting from accident, misuse or abuse or lack of reasonable care of the product.

In no case shall Emerald Energy Pty Ltd be liable for any incidental or consequential damages for breach of this or any other warranty express or implied whatsoever.

For full warranty details visit our website emeraldenergy.com.au

Emerald Energy Pty Ltd

ABN 86 632 172 368

L2, 12a Rodborough Road Frenchs Forest NSW 2086

2023.09