

LED FLOODLIGHT SLIMLINE SERIES USER MANUAL



IMPORTANT INFORMATION

Installation and maintenance work must be carried out by a licensed electrician.
Ensure power supply to the luminaire is isolated prior to installation and maintenance.
Suitable for indoor and outdoor use only in an ambient temperature ranging from -20°C to 40°C.

DESCRIPTION

MODEL	DIMENSION	RATING
EP-FL-70S	290x190x40mm	AC 220-240V, 50/60Hz, 70W

INSTALLATION

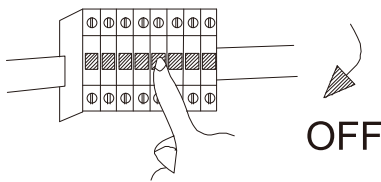
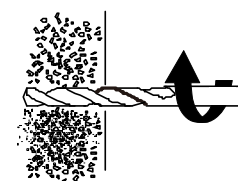
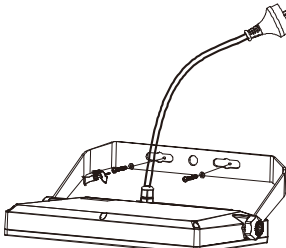
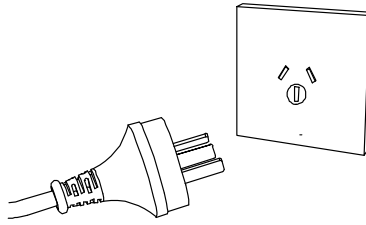
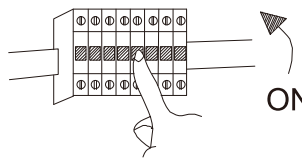
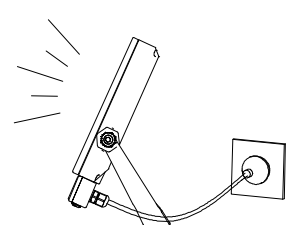
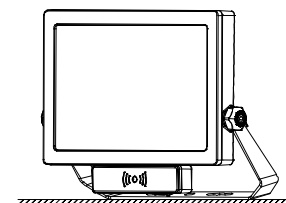
<p>1</p>  <p>Turn off power at the source.</p>	<p>2</p>  <p>Drill two holes in the mounting surface.</p>	
<p>3</p>  <p>Fasten bracket onto mounting surface.</p>	<p>4</p>  <p>Plug in.</p>	
<p>5</p>  <p>Restore power.</p>	<p>6</p>  <p>Luminaire light up.</p>	<p>7</p>  <p>Adjust beam direction by adjusting screws.</p>

REMOTE CONTROL SETTINGS

*This product only supports the following remote control functions.

Power Light

Indicates when a button is pressed and the remote control is active.
Default setting is sensor off.

Sensor On

 The sensor needs to be activated by pressing “Sensor ON” before use.
NOTE: Sensor must be on to save, or activate existing sensor settings.

Sensor OFF

 Sensor turns off, lights stay on permanently.

Pre-sets

 There are four ‘pre-set’ fixed programs built into the remote control.
Pre-sets scenes table below outlines pre-set programs.
NOTE: “Sensor ON” must be pressed before selecting the desired pre-set scene to ensure sensor settings are saved.

Hold Times

 Time period that the light remains 100% ON if no movement is detected.

Daylight Sensor

 Ambient light must be below the stated LUX level for sensor to turn the light fixture ON. Press OFF for light fixture to remain on when motion is detected, regardless of ambient light levels.

Detection Range

 Adjust the sensor sensitivity, detection range from 100% to 50%.

Test Button

Set light fixture into test mode (see table on next page).



DEFAULT SETTINGS

Detection = 100%
 Hold Time = 20mins (ON/OFF only)
 Daylight Sensor = 150lux

PRE-SETS SCENES

There are four scene modes fixed programs and one test mode built into the remote control.

PRE-SETS	HOLD TIME	DAYLIGHT LUX LEVEL	HOLD TIME
Scene 1	1min	50lux	100%
Scene 2	1hr	300lux	50%
Scene 3	10mins	150lux	100%
Scene 4	30mins	50lux	100%
Test Button	5secs	Off	100%

WIRING DIAGRAM

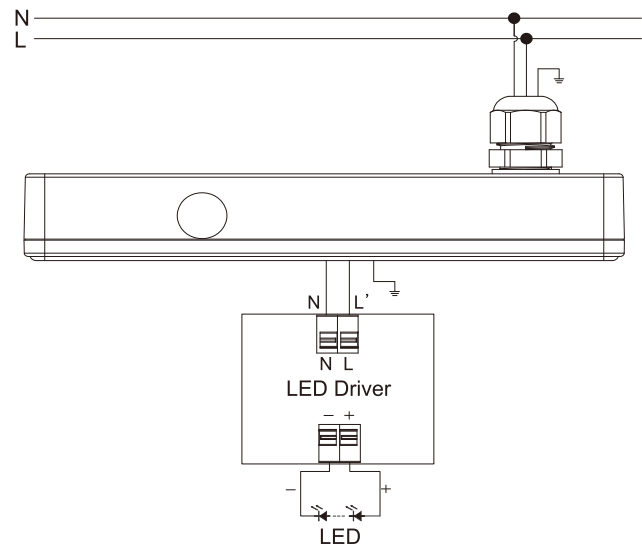
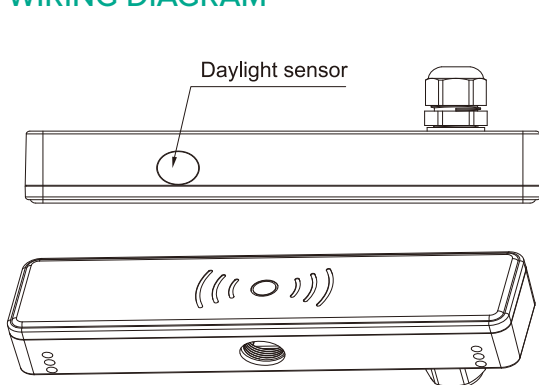

DETECTION PATTERN

